

预安装

玛琳
181x101cm

 ~ 182L	 220 V 0.58kW	 191x111x78 cm ~128 kg	 ~ 77 kg
---	---	---	--

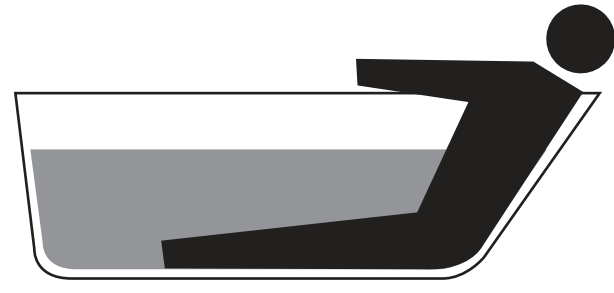
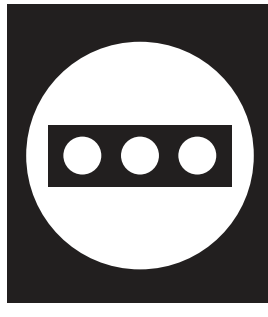
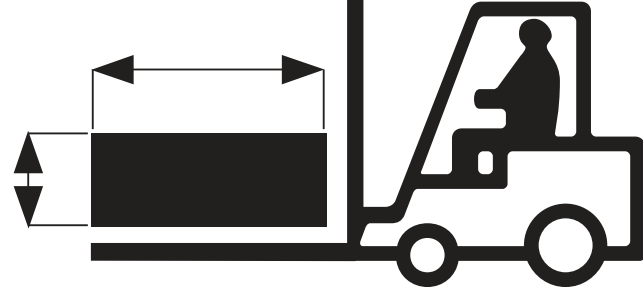
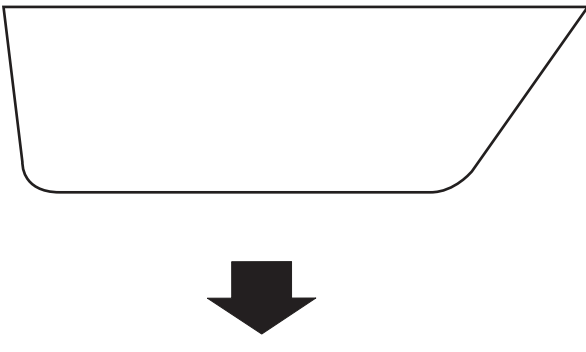
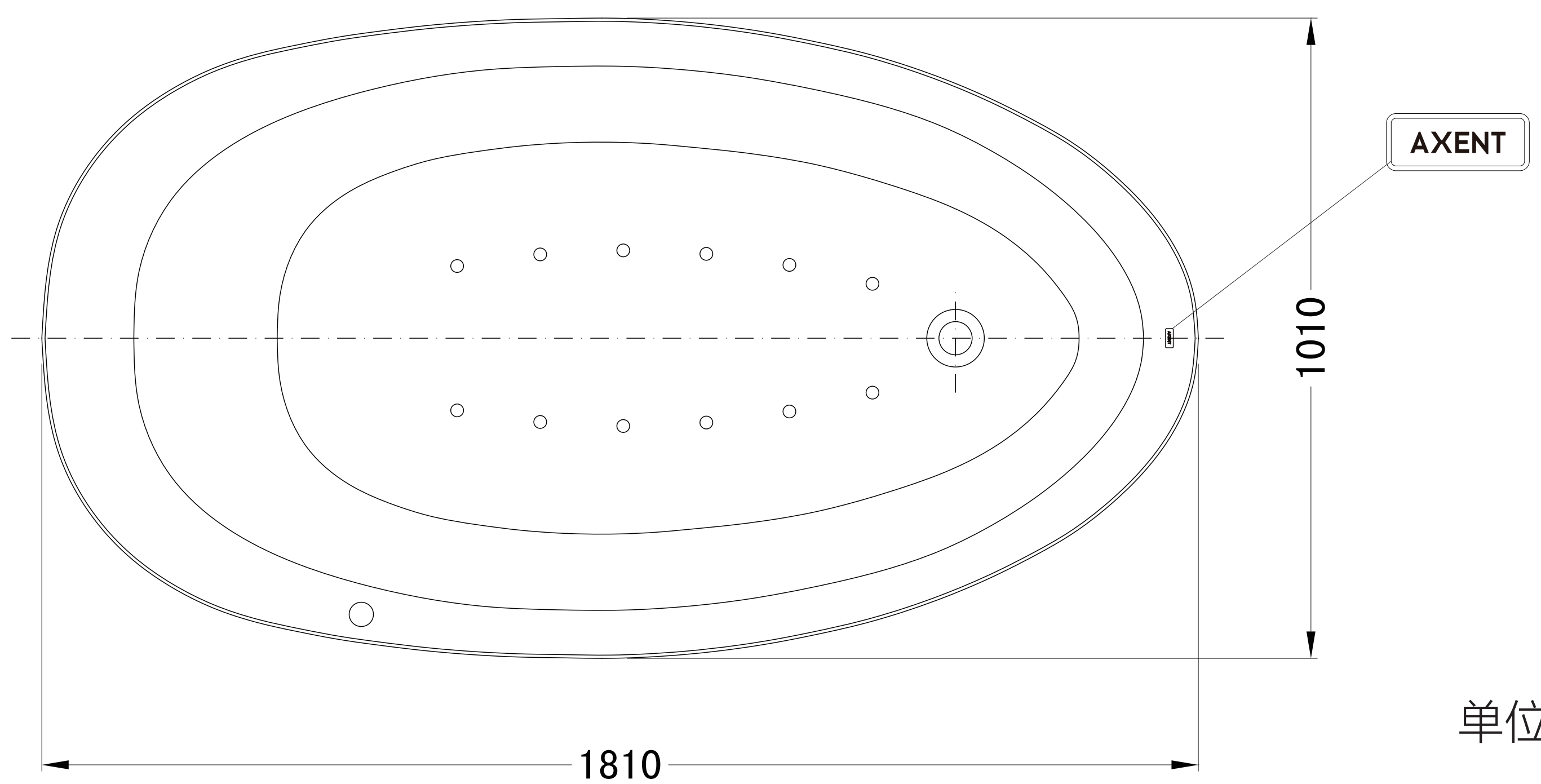
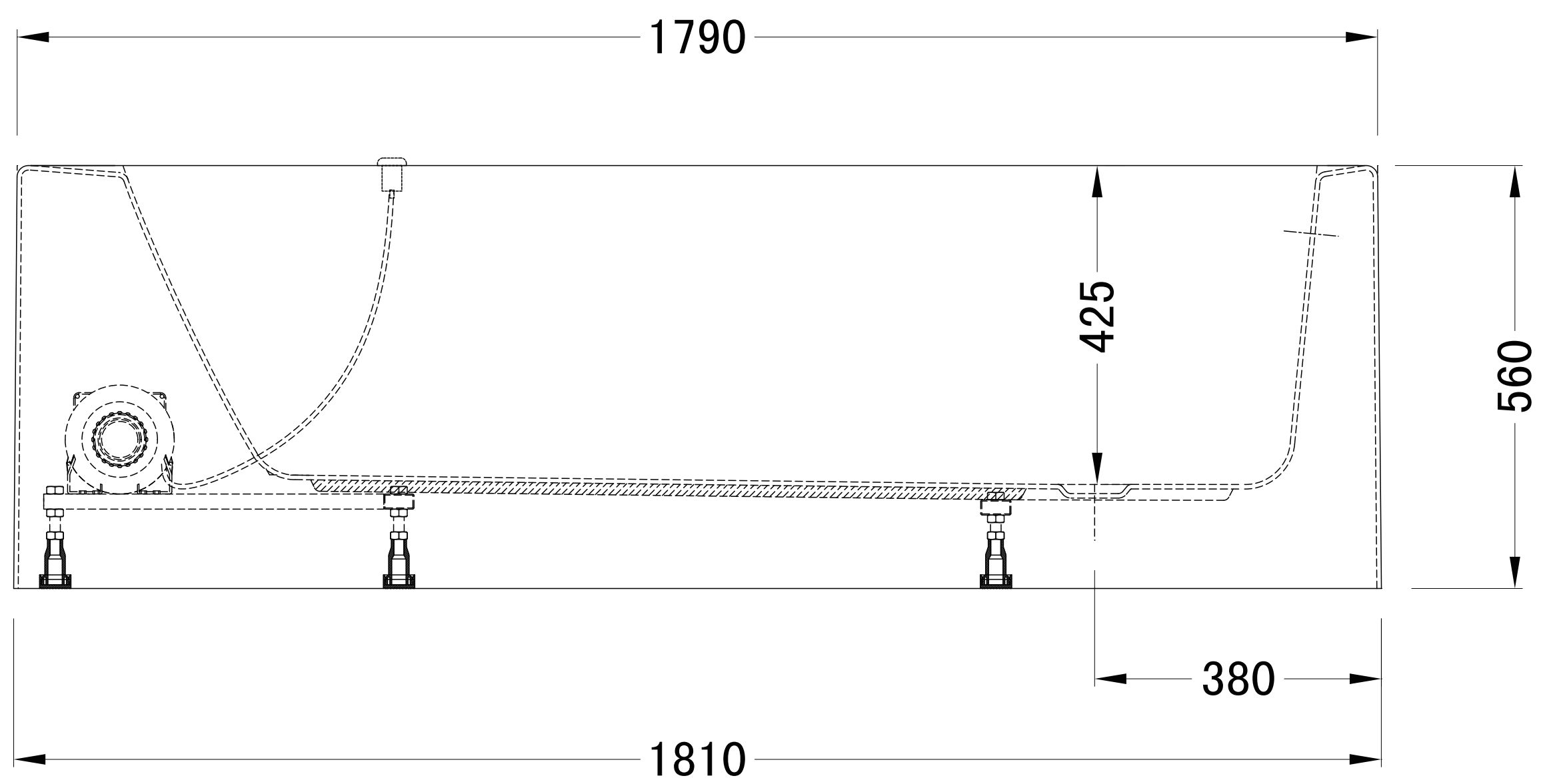

单位: mm

预安装

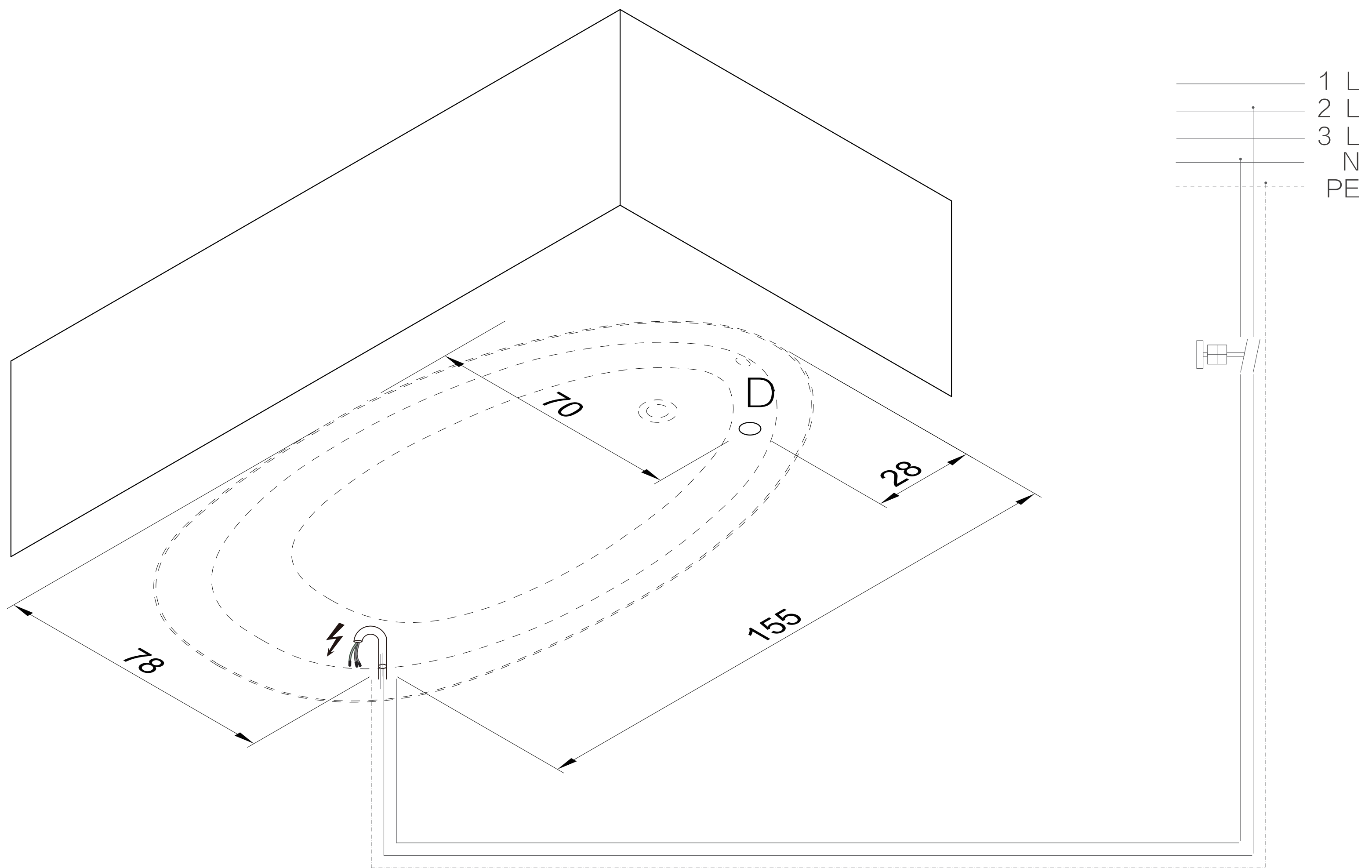

⚡ 地面预留电缆1.5m，电缆需做好防水处理
必须设置独立专用回路的供电系统，并加装漏电保护装置
供电电源请使用接地极的插座，接地泄漏端必须确保接地。

D:地面排水口

单位: cm
